

# URTSI – Universal RTS Interface

Part #1810872



## Overview:

The URTSI is an integration device that allows third party systems to control Radio Technology Somfy® motorized applications. The URTSI can control up to 16 RTS channels individually and/or as a group through RS232, RS485 and IR. Multiple URTSIs can be cascaded to control up to 256 channels, using the RS485 expansion port. This ensures optimal coverage of the RTS signal. Its simple design allows you to quickly duplicate programming from existing RTS transmitters and easily locate it within the space without a need for line of sight to the motorized window coverings.



## Features Summary:

- 16 channels of RTS control per URTSI
- Communicates with:
  - RS232
  - RS485
  - IR
- Using RS485
  - Control up to 16 URTSIs together for 256 channels in a system
  - Cascade up to 16 URTSIs with one wire
  - Power up to 16 URTSIs with one power supply in a system

## Technical Specifications:

- Power Input: 9 V DC, 200mA-UL approved
- Power Consumption: 20 mA
- Material: ABS
- Dimensions: 3" L x 4" W x 1.75" H
- Maximum Range: 65 feet radius (under optimal conditions)
- Operating Temperature Range: Ambient temperature
- Shipping Weight: 1 lb.
- LED: Bi-color
- Frequency: 433.42 Mhz

## What's in the Box:

- URTSI
- Antenna
- Power Supply
- DB9 to RJ45 for RS232
- Instructions

## Optional Accessories:

- IR Receiver #9015078
- IR Transmitter #1810498
- DB9 to RJ45 for RS232 #9015028
- DB9 to RJ45 for RS485 #9015029
- RS232 to RS485 Converter #1810496

## Connections and Indicators:

Front View

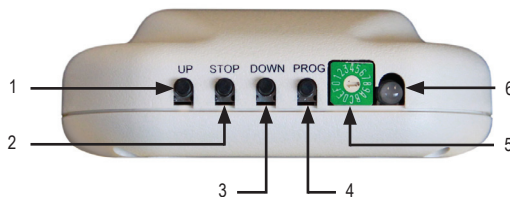

ELEMENT	FUNCTION
1 Up Button	RTS (Test) Up directional button
2 Stop Button	RTS (Test) Stop directional button
3 Down Button	RTS (Test) Down directional button
4 Programming Button	RTS Programming button
5 Rotary Dial	<b>Programming:</b> RTS Channel selector <b>Operation:</b> URTSI Address selector (RS485) (A-0 = CH 10-16)
6 Bi-Color LED	Green = Power; Red Flash = RTS Transmission

Back View

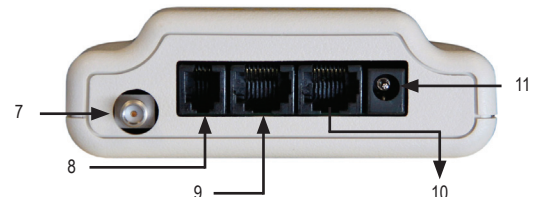

ELEMENT	FUNCTION
7 Antenna	RTS antenna
8 IR Sensor Input	RJ9 port for Somfy's IR receiver (9015078)
9 RS232 or RS485 Input	RJ45 for RS232 or RS485 serial input
10 RS485 Expansion	RJ45 for RS485 expansion
11 Power	3.5mm jack for included power supply (9V DC 200mA)

## Cable Pinouts:

### RS232 input or RS485 input

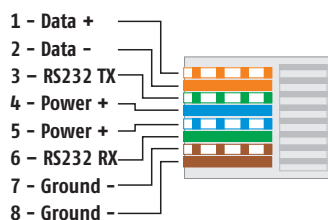

### RS485 expansion

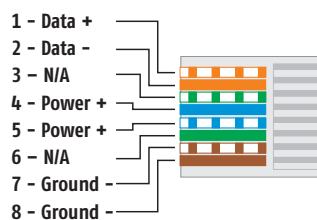

### RJ45 to DB9 RS232

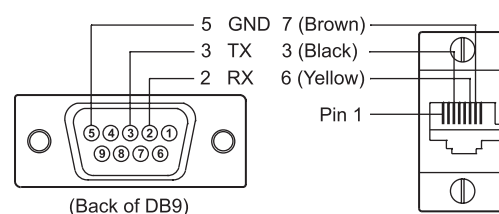

## Dimensions:

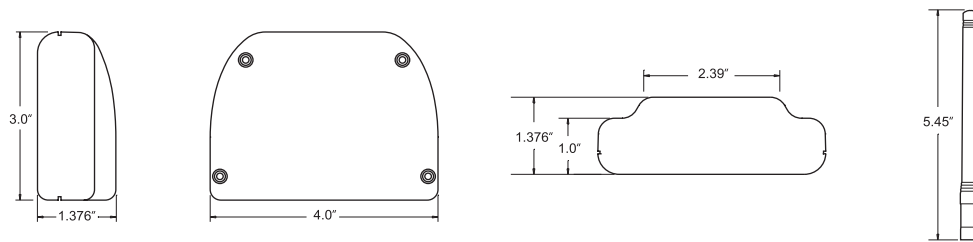

## Wiring Best Practice:

- Somfy recommends placing the URTSI in a central location and that each channel is tested to ensure proper communication between the URTSI and motorized window covering prior to integration.
- Somfy recommends using specified adapters and cables. Making your own cable is not recommended.

### RS232

- Somfy recommends using a DB9 to RJ45 adapter.
- Set the rotary dial arrow back to 1, this will ensure proper commands to be sent to the unit.

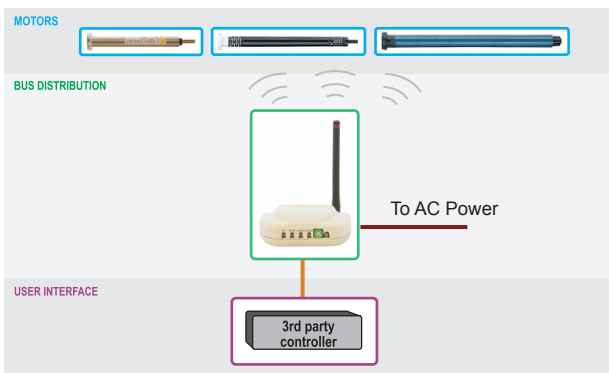

### IR

- When connecting to the URTSI using IR please use the Somfy branded IR Receiver (9015078) and attach an IR emitter from the control system.
- The learnable codes come from the Somfy multichannel IR transmitter.
- Making your own cable and trying to hardwire into the URTSI is NOT recommended.

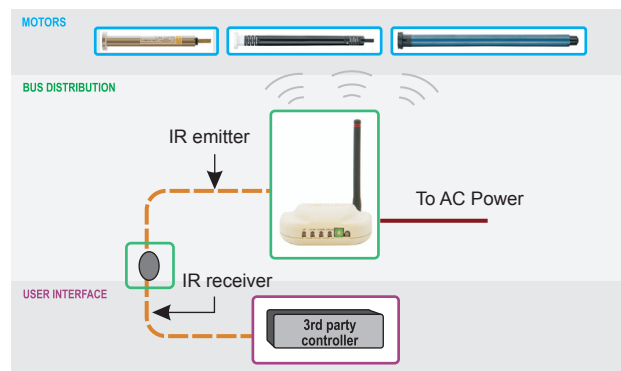

### RS485 Single

- Somfy recommends using a DB9 to RJ45 adapter.
- DO NOT USE the DB9 to RJ45 adapter that was included in the box (it is pinned out for RS232).
- Set the rotary dial arrow back to 1, this will ensure proper commands to be sent to the unit.

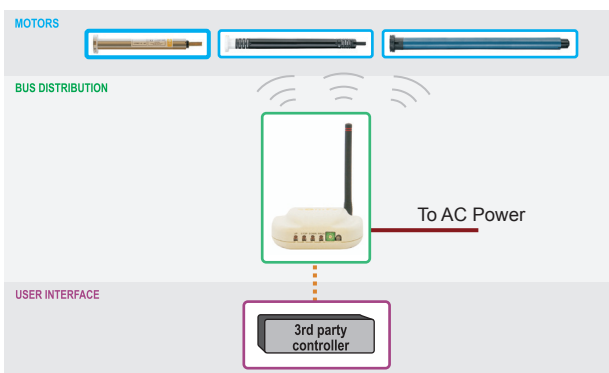

### RS485 Multiple

- Somfy recommends using a DB9 to RJ45 adapter.
- DO NOT USE the DB9 to RJ45 adapter that was included in the box (it is pinned out for RS232).
- Set the rotary dial to the appropriate address.
- You can cascade a total of 16 URTSIs on 1 bus line for a total of 256 available RTS channels.
- When cascading URTSIs together on a bus line, you only need to power one of the units.

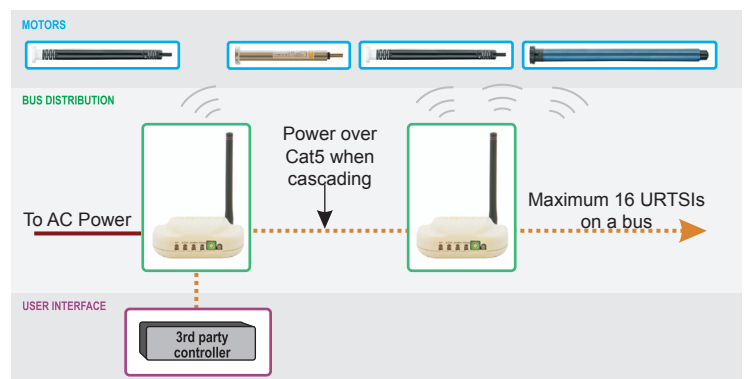

## Wiring Connection Types

Wireless	Third Party	Power
RTS	RS232 - 50' max	110V AC
WiFi	RS485 - 4K' max	24V DC
Z-Wave®	IR	12V DC
ZigBee®	Ethernet	9V DC
		5V DC